

Chain lashing

C 1

C1A

Hook - hook

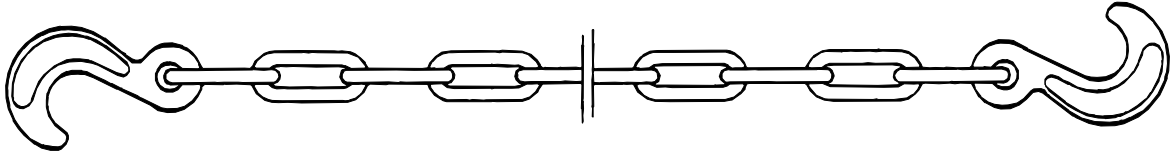

C1B

Hook - elephant foot

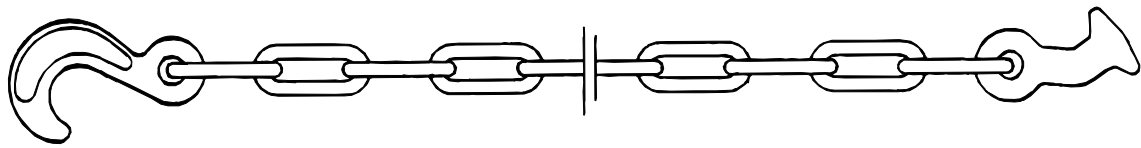

C1C

Hook - shackle

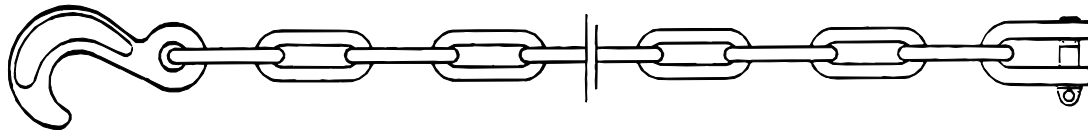

C1D

Hook one end

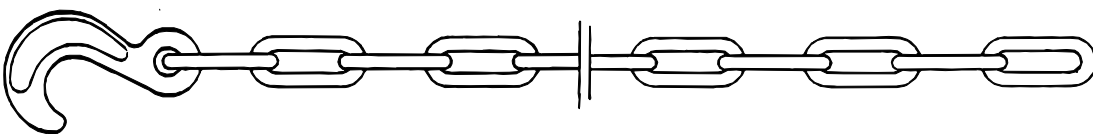

Chain diameter (mm)	Inside length (mm)	Inside width (mm)	Weight (kg/m)	Proof load kN	Min. Break Load kN
9	57	16	1,4	60,0	100,0
11	65	19	2,1	90,0	150,0
13	80	22	2,6	120,0	200,0
16	88	27	4,6	160,0	320,0

General specifications:

- Material: Alloy steel, grade 80 / forged end fittings
- Finish: Painted / galvanized
- Certificate: Workshop certificate, class certificate upon request.
- Remark: Splint type hook as standard (not shown)
10% strength reduction for galvanizing
End fittings may also be fitted with shackle.



Seasafe Transport A/S

YOU NAME IT - WE LASH IT

Filipstadveien 5, N-0250 OSLO, Norway Phone: + 47 - 23 23 96 00 Telefax: + 47 - 23 23 96 01 E-mail: post@seasafe.no

Securing devices

C 2 - C 4

C 2.1
Eye type

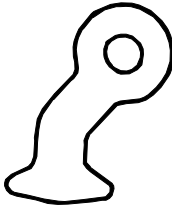

C 2.2
Clevis type

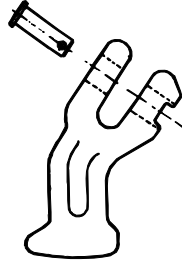

C 3.1
Eye type

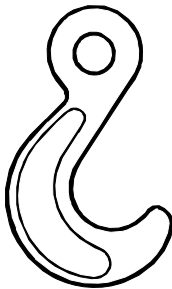

C 3.2
Clevis type

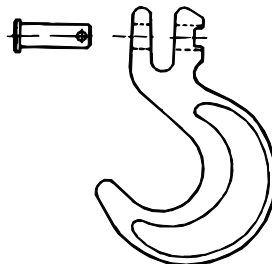

C 3.3
Splint type

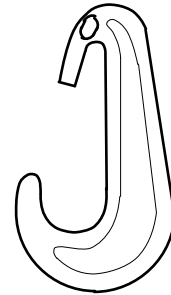

C 4.1
Standard

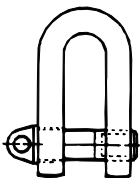

C 4.2
Straight type

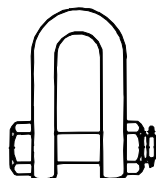

C 4.3
Bow type

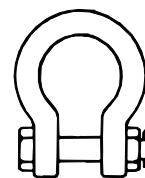

Type	For chain diameter (mm)	MBL tension (kN)	Weight (kg)
C 2.1 C 2.2	9/11/13	200	1,0
C 3.1 C3.2 C3.3	9/11/13	100/150/200	0,6/0,8/1,3
C4.1 C4.2 C4.3	9/11/13	100/150/200	0,4/0,5/0,7

General specifications:

Material: Forged steel
 Finish: Painted / galvanized
 Certificate: Workshop certificate, class certificate upon request.
 Remark: Other design, dimensions, material and finish upon request.



Seasafe Transport A/S

YOU NAME IT - WE LASH IT

Filipstadveien 5, N-0250 OSLO, Norway Phone: + 47 - 23 23 96 00 Telefax: + 47 - 23 23 96 01 E-mail: post@seasafe.no

Chain levers

C 5 - C 7

C 5

Chain lever without climb hook

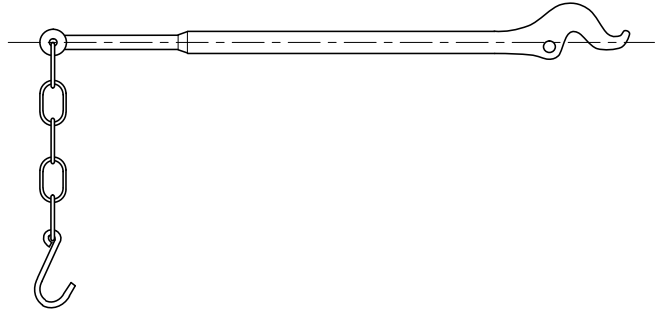

C 6

Chain lever with climb hook

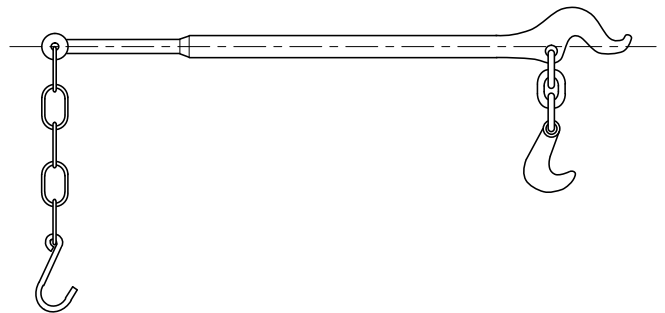

C 7

Extension handle

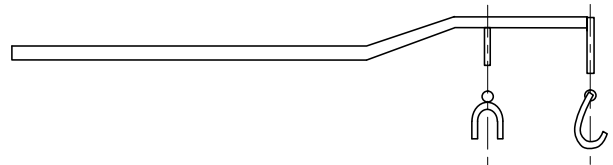

⚙️ Instructions for use:

1. Put in lever
2. Pull it down
3. Secure lever

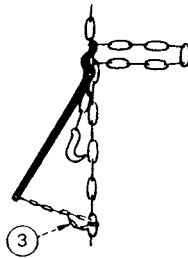
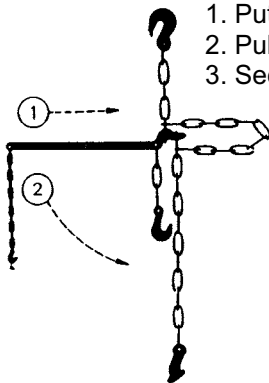

⚙️ For further tightening:

4. Swing in hook
5. Pull back lever
6. Grab next link and pull lever down again

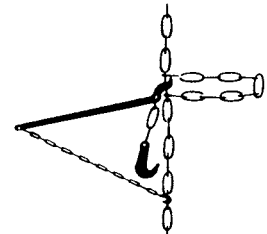
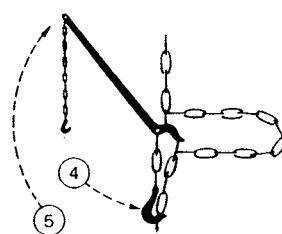

Type	For chain diameter (mm)	MBL tension (kN)	Weight (kg)
C 5.1	9	100	2,6
C 5.2	11	150	2,8
C 5.3	13	200	4,0
C 6.1	9	100	3,5
C 6.2	11	150	3,9
C 6.3	13	200	6,0
C 7	9/11/13	---	3,5

General specifications:

- Material: Forged steel
- Finish: Painted / galvanized
- Certificate: Workshop certificate, class certificate upon request.
- Remark: Other design, dimensions, material and finish upon request.



Seasafe Transport A/S

YOU NAME IT - WE LASH IT

Filipstadveien 5, N-0250 OSLO, Norway Phone: + 47 - 23 23 96 00 Telefax: + 47 - 23 23 96 01 E-mail: post@seasafe.no

Turnbuckles & load binders

C 8 - C 11

C 8

Open body turnbuckle
with double chain hook

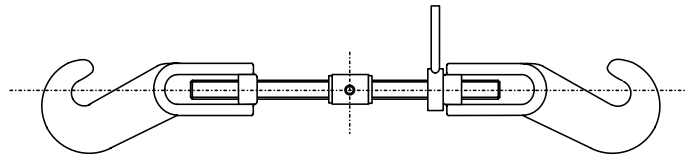

C 9

Closed body turnbuckle
hook - jaw
C 9.1 elephant foot lower end
C 9.2 hook lower end

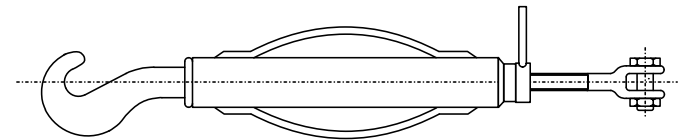

C 10.1

Load binder
ratchet type

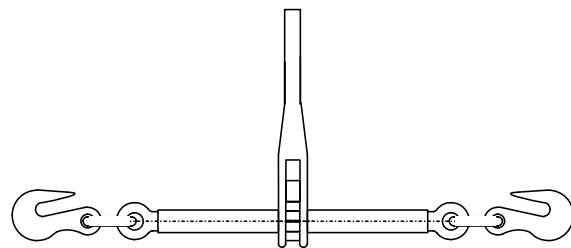

C 10.2

Load binder
walking type

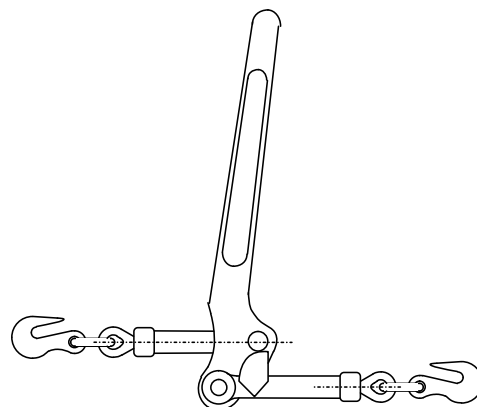

C 11

Spindle tensioner



Type	MBL (kN) tension	Weight (kg)	Take-up (mm)
C 8	200	5,0	200
C 9	200	6,0	200
C 10.1	200	6,5	200
C 10.2	150	6,0	endless
C 11	200	4,0	200

General specifications:

Material: Forged steel / shipbuilding steel

Finish: Galvanized / untreated

Certificate: Workshop certificate, class certificate upon request.

Remark: Other design, dimensions, material and finish upon request.



Seasafe Transport A/S

YOU NAME IT - WE LASH IT

Filipstadveien 5, N-0250 OSLO, Norway Phone: + 47 - 23 23 96 00 Telefax: + 47 - 23 23 96 01 E-mail: post@seasafe.no

Quick lash & Trailer winch

C 12 - C 13

C 12

Quick lash
chain tensioner with shock absorber
C 12.1 hook - elephant foot
C 12.2 hook - hook

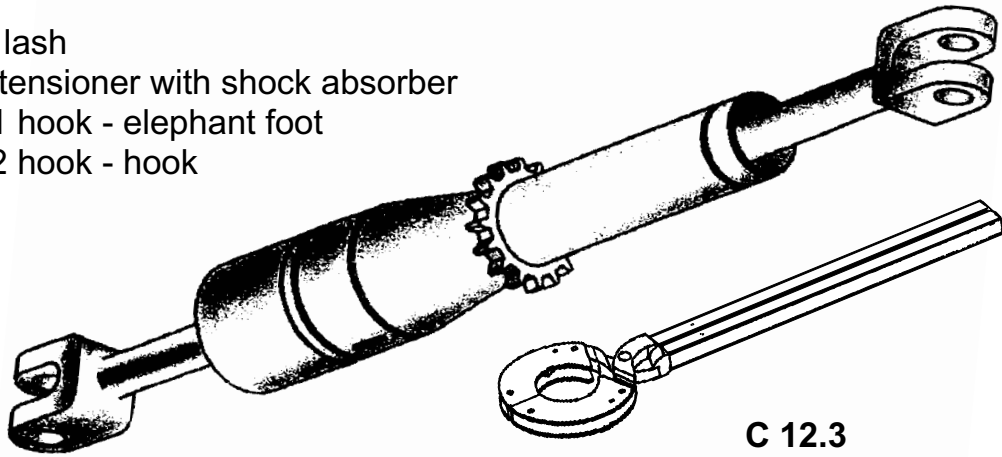

C 12.3

Ratchet tightener
for quick lash

C 13

Trailer winch
C 13.1 hook - elephant foot
C 13.2 hook - hook

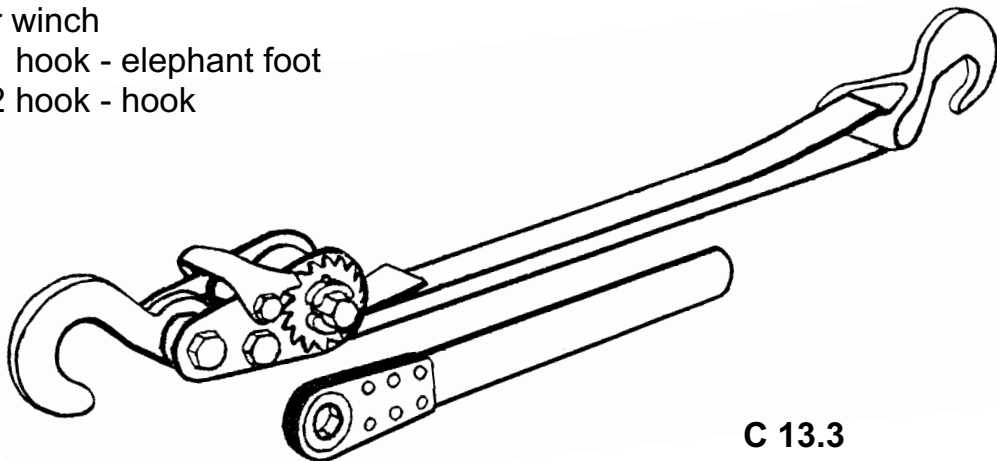

C 13.3

Ratchet wrench
for trailer winch, 28 mm

Type	MBL (kN) tension	Weight (kg)	Take-up (mm)
C 12.1 C 12.2	200	5,5	200
C 12.3	---	1,0	---
C 13.1 C 13.2	150/200	9,0	unlimited
C 13.3	---	2,0	

(28 mm hex)

General specifications:

Material: Forged steel / shipbuilding steel / polyester

Finish: Painted / galvanized

Certificate: Workshop certificate, class certificate upon request.

Remark: C 13 is supplied with 65 mm 100% polyester webbing material, length upon request.



Seasafe Transport A/S

YOU NAME IT - WE LASH IT

Filipstadveien 5, N-0250 OSLO, Norway Phone: + 47 - 23 23 96 00 Teleax: + 47 - 23 23 96 01 E-mail: post@seasafe.no

Speedlash with chain clutch

C 14

C 14.1

Speedlash NL20
with elephant foot

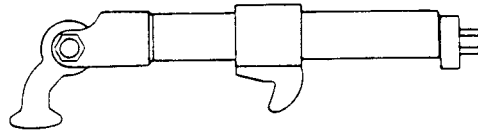

C 14.2

Speedlash NL20
with hook

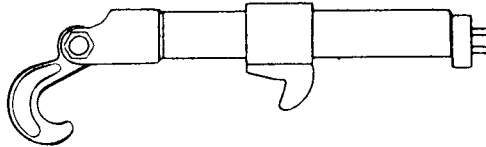

C 14.3

Speedlash NL20
with pelican hook

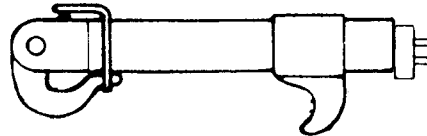

C 14

Speedlash NL-20 combined
with 13 mm chain, mbl: 20 tons

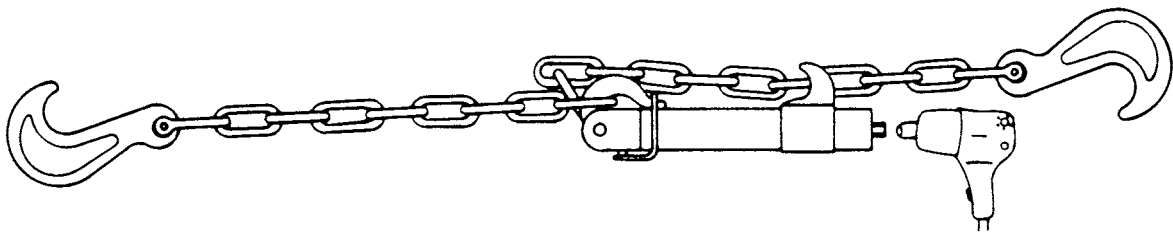

Type	MBL (kN) tension	Weight (kg)	Take-up (mm)
C 14.1	200	6,0	250
C 14.2	200	6,0	250
C 14.3	200	6,0	250
			250

General specifications:

Material: Forged steel / shipbuilding steel

Finish: Galvanized

Certificate: Workshop certificate, class certificate upon request.

Remark: Modified designs available
C 14.3 may be supplied with climb hook and chain.



Seasafe Transport A/S

YOU NAME IT - WE LASH IT

Filipstadveien 5, N-0250 OSLO, Norway Phone: + 47 - 23 23 96 00 Telefax: + 47 - 23 23 96 01 E-mail: post@seasafe.no

Speedlash accessories

C 15

C 15.1

Impact tool hammer
pneumatic, 7 kg/cm²

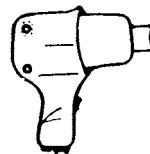

C 15.2

Hexagon sleeve
24 mm

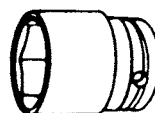

C 15.3

Rubber hose

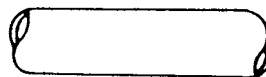

C 15.4

Quick release connection
male + female



C 15.5

Claw coupling

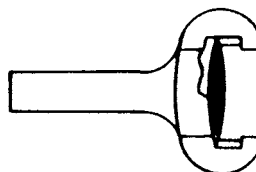

C 15.6

Ratchet for Speedlash



Seasafe Transport A/S

YOU NAME IT - WE LASH IT

Filipstadveien 5, N-0250 OSLO, Norway Phone: + 47 - 23 23 96 00 Telefax: + 47 - 23 23 96 01 E-mail: post@seasafe.no

Trailer horses

C 16

C16A
Trailer horse

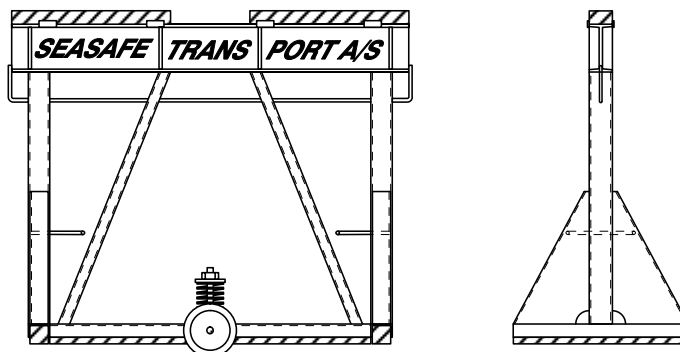

C16B
Trailer horse

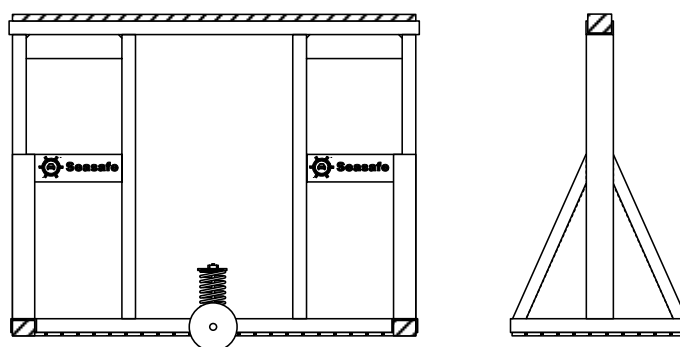

C16C
Trailer horse

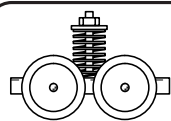
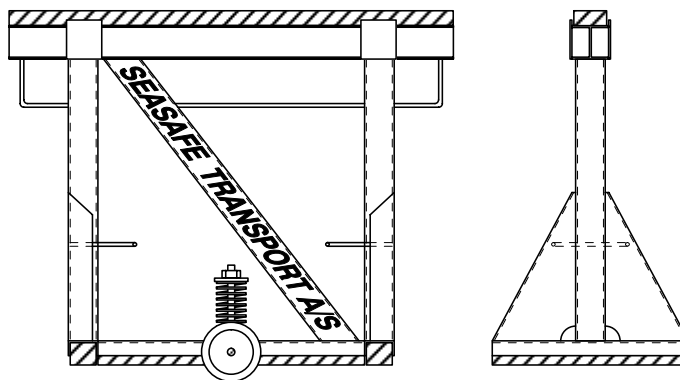

Double wheel assemblies
available all models

Type	Length (mm)	Height (mm)	MBL (kN) tension	Weight (kg)
C16A	1500	1250	1000	140
C16B	1420	1250	1000	140
C16C	1500	1250	1000	160

General specifications:

- Material: Shipbuilding steel
- Finish: Painted or galvanized
- Certificate: Workshop certificate, class certificate upon request.
- Remark: Other design, dimensions, material and finish upon request.



Seasafe Transport A/S

YOU NAME IT - WE LASH IT

Filipstadveien 5, N-0250 OSLO, Norway Phone: + 47 - 23 23 96 00 Telefax: + 47 - 23 23 96 01 E-mail: post@seasafe.no

Trailer jacks & wheel chocks

C 17 - C 20

C 17
Trailer jack
with handwheel

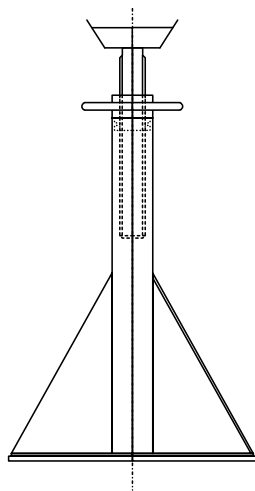

C 18
Mafi Jack
with hand wheel

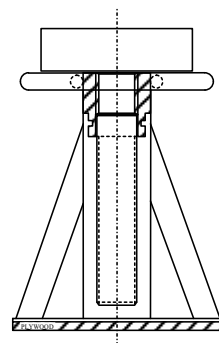

C 19
Trailer wheel chock
rubber

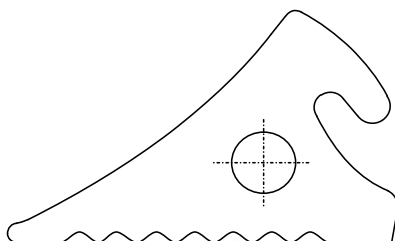

C 20
Car wheel chock
rubber

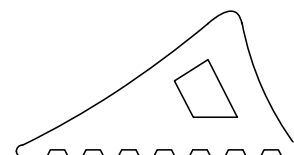

Type	MBL (kN) tension	Weight (kg)	Dimensions mm
C 17	500	35,0	H 950-1250
C 18	500	14,0	H 370-580
C 19	---	5,5	290x150x190
C 20	---	2,0	210x100x120

General specifications:

- Material: Forged steel / Shipbuilding steel / rubber
- Finish: Painted / untreated
- Certificate: Workshop certificate, class certificate upon request.
- Remark: Other design, dimensions, material and finish upon request.



Seasafe Transport A/S

YOU NAME IT - WE LASH IT

Filipstadveien 5, N-0250 OSLO, Norway Phone: + 47 - 23 23 96 00 Telefax: + 47 - 23 23 96 01 E-mail: post@seasafe.no

Railway jacks & chocks

C 21 - C 23

C 21
Railway jack
with hand wheel

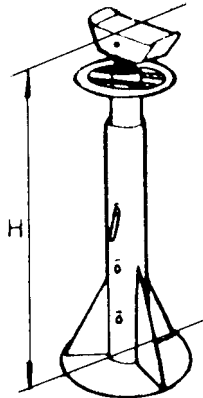

C 22
Railway jack
rack & pinion type

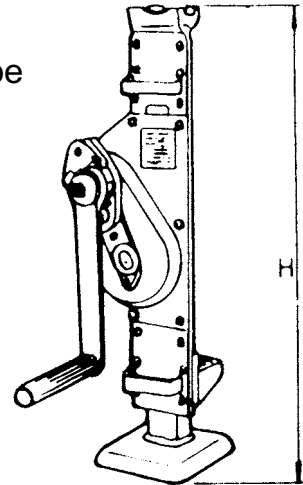

C 23
Railway chock
single type shown
double type also
available

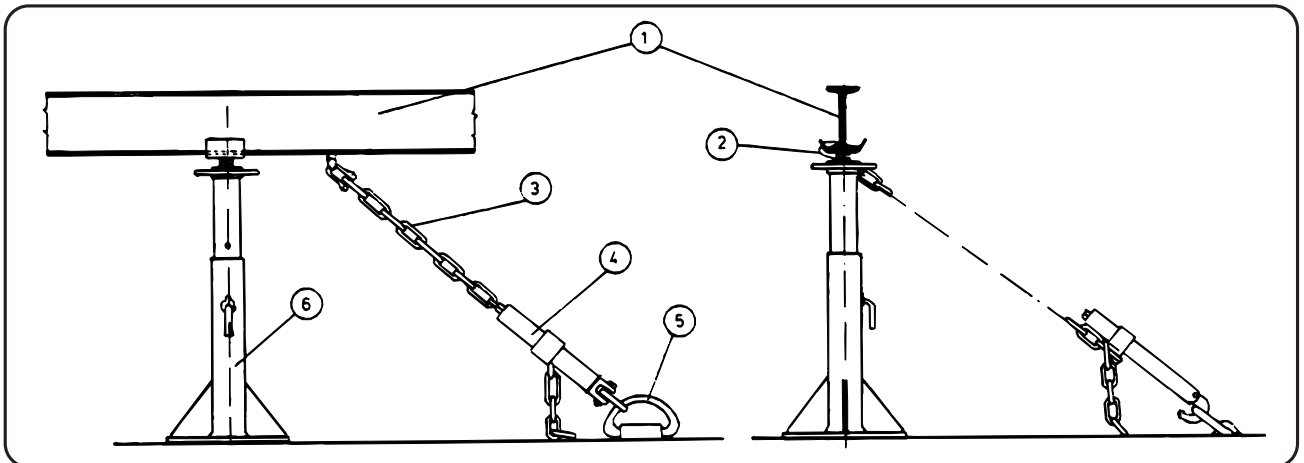
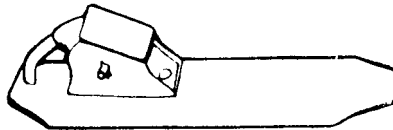

Type	Strength (kN)	Weight (kg)	Dimensions mm
C 21	200	38,0	H 760-1300
C 22	70/100	40,0	H 90-320/770-1090
C 23	---	8,0	520x76x125

General specifications:

Material: Forged steel / shipbuilding steel

Finish: Painted

Certificate: Workshop certificate, class certificate upon request.

Remark: Other design, dimensions, material and finish upon request.



Seasafe Transport A/S

YOU NAME IT - WE LASH IT

Filipstadveien 5, N-0250 OSLO, Norway Phone: + 47 - 23 23 96 00 Telefax: + 47 - 23 23 96 01 E-mail: post@seasafe.no

Corner protectors

C 24 - C 26

C 24

Corner protector
for chain lashings
galvanized steel

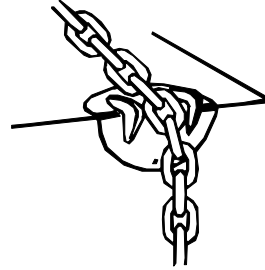

C 25

Corner protector
pvc, for paper rolls

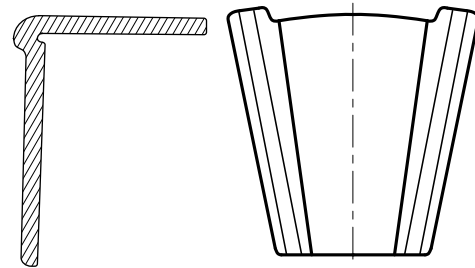

C 26

Corner protector
pvc, 190x190 mm
length: 6,0 m
other upon request

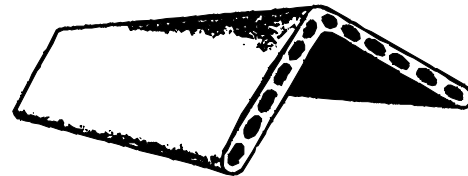

Type	MBL (kN) tension	Weight (kg)	Dimensions (mm)
C 24	---	0,75	Ø200xT3,0
C 25	---	0,3	195x145 W160
C 26	---	3,1/m	190x190 T20

General specifications:

Material: Steel / pvc plastic

Finish: Galvanized / untreated

Certificate: Workshop certificate, class certificate
upon request.

Remark: Other design, dimensions, material
and finish upon request.



Seasafe Transport A/S

YOU NAME IT - WE LASH IT

Filipstadveien 5, N-0250 OSLO, Norway Phone: + 47 - 23 23 96 00 Telefax: + 47 - 23 23 96 01 E-mail: post@seasafe.no

Cargo nets & Dunnage bags

C 27 - C 30

C 27

Walking board
plywood, laminated wood
1200 x 2440 x 7,5 mm

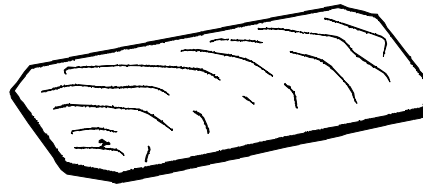

C 28

Cargo net
polypropylene

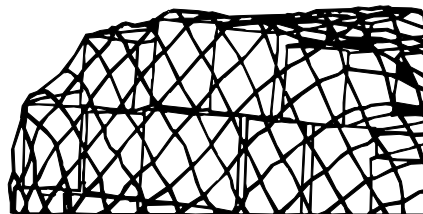

C 29

Dunnage bags
paper, pvc or rubber
different sizes upon
request

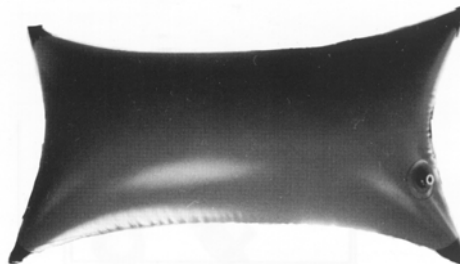

C 30

Marine fenders
low weight - easy handling
pvc/polyester or rubber
sizes upon request



General specifications:

Material: PVC/polyester / rubber / paper / polyprop.

Finish: Untreated

Certificate: Workshop certificate, class certificate
upon request.

Remark: Other design, dimensions, material
and finish upon request.



Seasafe Transport A/S

Filipstadveien 5, N-0250 OSLO, Norway Phone: + 47 - 23 23 96 00 Telefax: + 47 - 23 23 96 01 E-mail: post@seasafe.no

YOU NAME IT - WE LASH IT

Car, truck & web lashings

C 31 - C 35

C 31

Car lashing
flat hooks both ends
excenter handle tightener
optional loop upper end

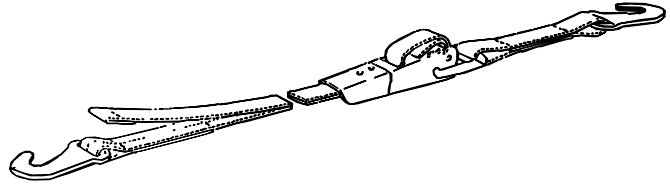

C 32

Web lashing
thread type hooks both ends
optional elephant foot lower end
ratchet tightener with transport securing



C 33

Web lashing
forged hooks and elephant foot
optional hook lower end
ratchet tightener with transport securing

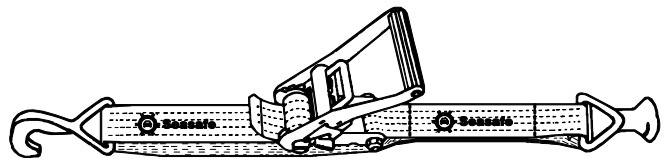

C 34

Web straps and slings
various dimensions and strengths
details upon request

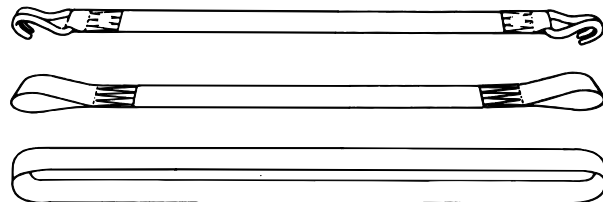

C 35

Round straps and slings
various dimensions and strengths
details upon request

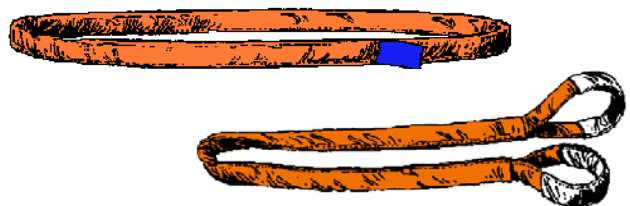

Type	MBL tension	Weight (kg)	Webbing width (mm)
C 31	1200-2000 kg	0,7	25
C 32	2,5-15,0 t	varies	35-70
C 33	5,0-12,0 t	4,0	50
C 34	upon request	varies	upon request
C 35	upon request	varies	upon request

General specifications:

Material: High strength steel / polyester webbing
Finish: Yellow chromated / galvanized / painted / plastic coated
Certificate: Workshop certificate, class certificate upon request.
Remark: Other design, dimensions, material and finish upon request.



Seasafe Transport A/S

YOU NAME IT - WE LASH IT

Filipstadveien 5, N-0250 OSLO, Norway Phone: + 47 - 23 23 96 00 Telefax: + 47 - 23 23 96 01 E-mail: post@seasafe.no

Timber lashing

C 36 - C 38

C 36

Speedlash NL20
with pelican hook
and climbing chain
mbl: 20 tonnes

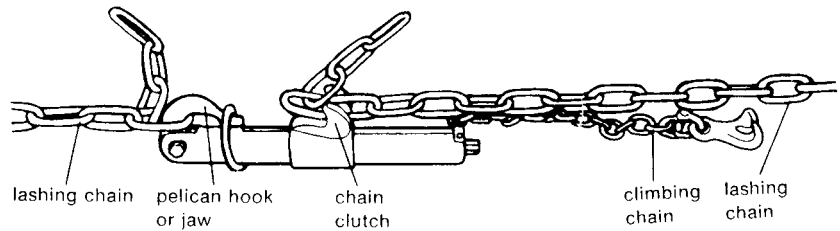

C 37

Rigging screw
slip hook - pear link
galvanized, mbl: 15 t

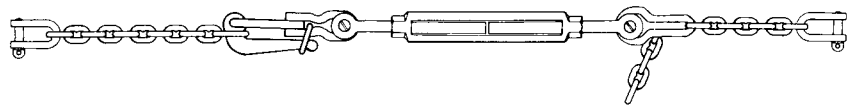

C 38

Rigging screw
slip hook both ends
mbl: 15 t

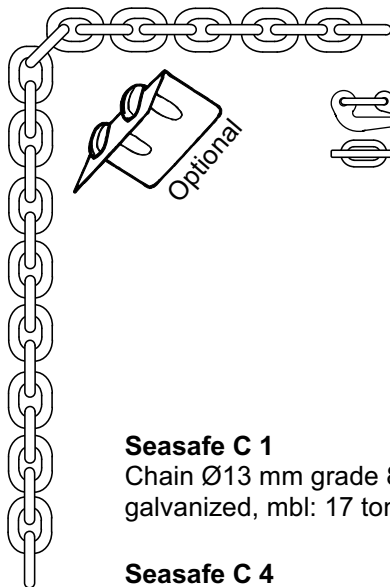
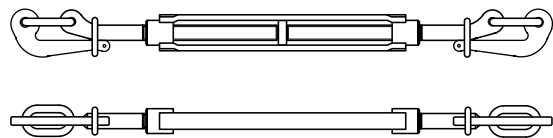

Seasafe C 1
Chain Ø13 mm grade 80
galvanized, mbl: 17 tonnes



Seasafe C 4
Shackle M24 galvanized
with 50 mm opening
mbl: 17 tonnes

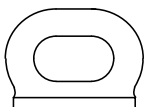

Seasafe A 15.1
Lashing plate / pade eye
mbl: 20 tonnes



Seasafe C 37 / C 38
Rigging screw
mbl: 15 tonnes

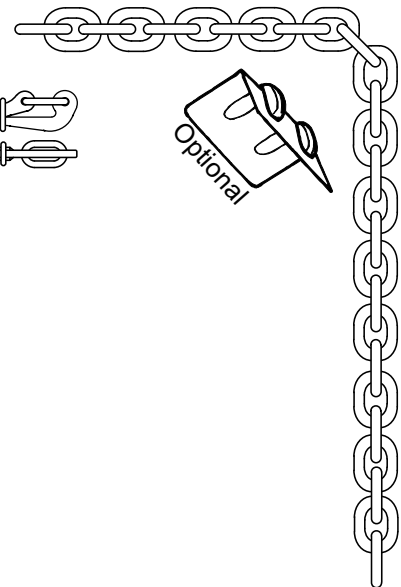

In accordance with
Canadian Coast Guard Requirements

$$\text{HEIGHT}_{(\text{CARGO} - \text{MAX})} = 0,33 \times B_{(\text{MLD.})}$$

$$\text{BREAK LOAD}_{(\text{MIN.})} = 30\,000 \text{ LBS} = 13,6 \text{ T}$$



Seasafe Transport A/S

YOU NAME IT - WE LASH IT

Filipstadveien 5, N-0250 OSLO, Norway Phone: + 47 - 23 23 96 00 Telefax: + 47 - 23 23 96 01 E-mail: post@seasafe.no

Lashing bins & racks

C 39 - 40

C 39

Lashing bin
1300x1140x730 mm

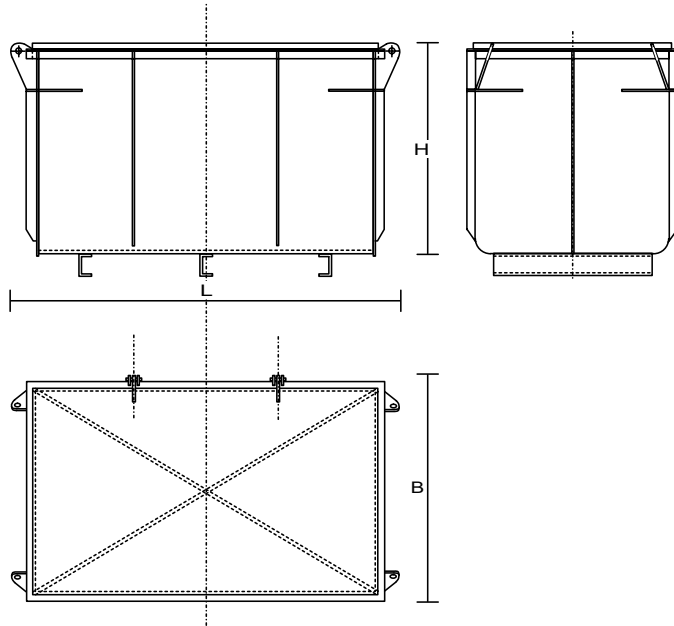

C 40

Lashing rack
stackable 20 feet
half height container

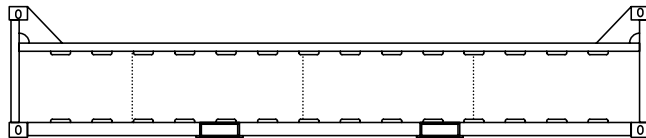

also available:
Storage rack for
lashing bins type C39

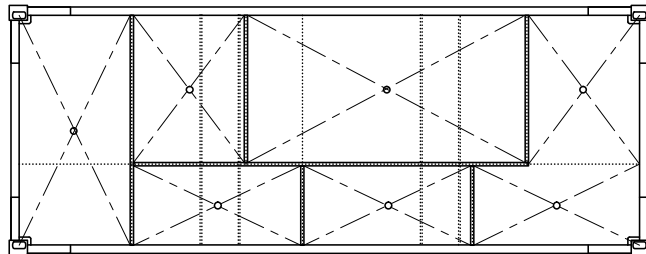

Lashing bins & racks

Lashing bins & racks are supplied in accordance with customer specific requirements.

Although a general standard is available, the project specific details are significantly affecting the general design to such an extent that it is not appropriate to include further details in this catalogue.

Detail drawings available upon request.

General specifications:

- Material: Shipbuilding steel
- Finish: Painted or galvanized
- Certificate: Workshop certificate, class certificate upon request.
- Remark: Other design, dimensions, material and finish upon request.



Seasafe Transport A/S

YOU NAME IT - WE LASH IT

Filipstadveien 5, N-0250 OSLO, Norway Phone: + 47 - 23 23 96 00 Fax: + 47 - 23 23 96 01 E-mail: post@seasafe.no

Roll-Lash system (Pat. Pend)

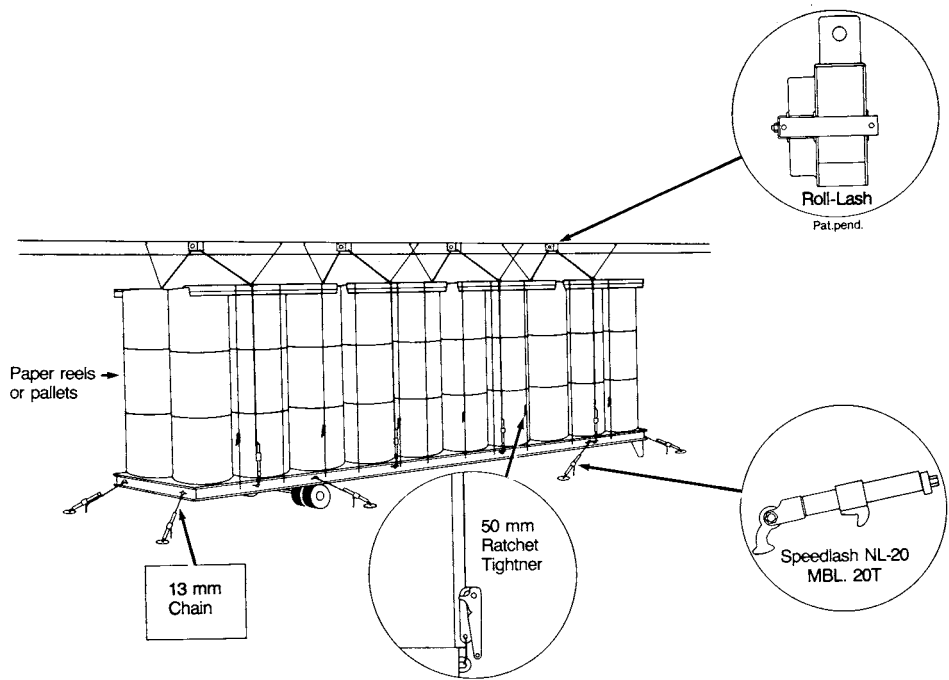
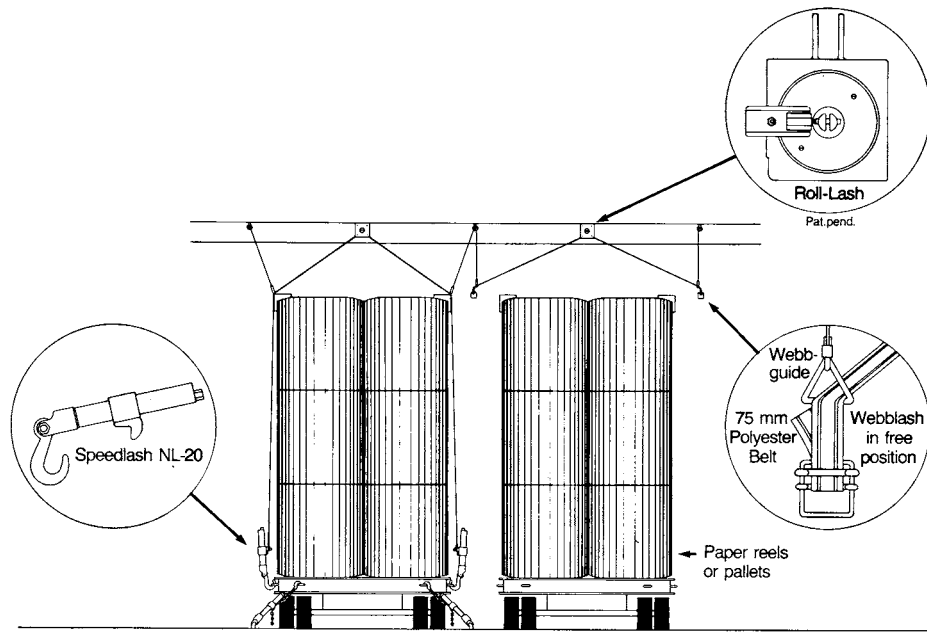

Seasafe's patented Roll-Lash system; designed to prevent cargo from shifting on roll trailers

The system is based on a series of spring loaded drums permanently secured to the deck head above the trailer lanes. 10 tonne capacity web lashings are pulled down with a boat hook and attached to standard Seasafe tensioners, which again are attached to lashing points on the trailer.

The trailer itself is secured to the deck using 13 mm chains, again secured with Seasafe's Speedlash. AT the discharge point, the Roll-Lash webbing is released, and the belts automatically wind back into the winch housings, much like a car seat belt.



Seasafe Transport A/S

YOU NAME IT - WE LASH IT

Filipstadveien 5, N-0250 OSLO, Norway Phone: + 47 - 23 23 96 00 Telefax: + 47 - 23 23 96 01 E-mail: post@seasafe.no

Semi trailer lashing



Seasafe Transport A/S

YOU NAME IT - WE LASH IT

Filipstadveien 5, N-0250 OSLO, Norway Phone: + 47 - 23 23 96 00 Telefax: + 47 - 23 23 96 01 E-mail: post@seasafe.no

Car lashing and Roll trailer arr.

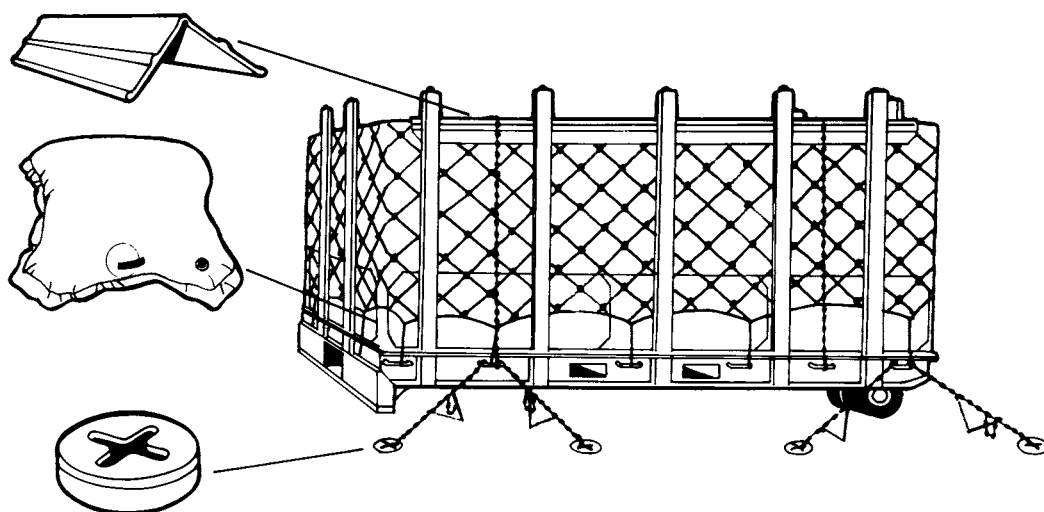
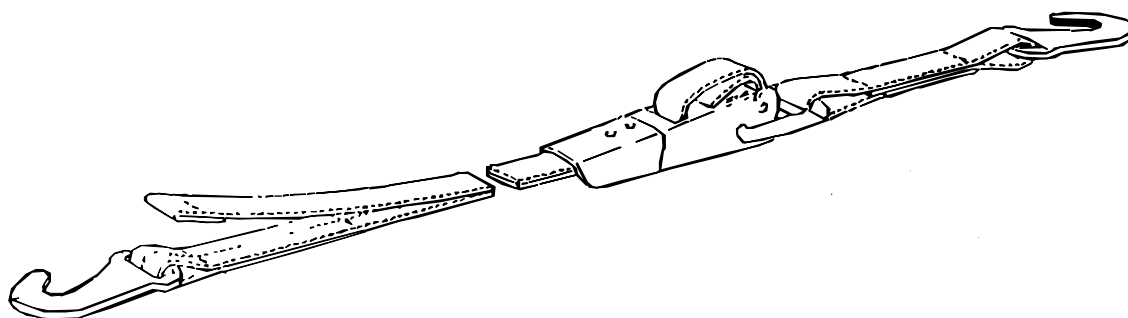
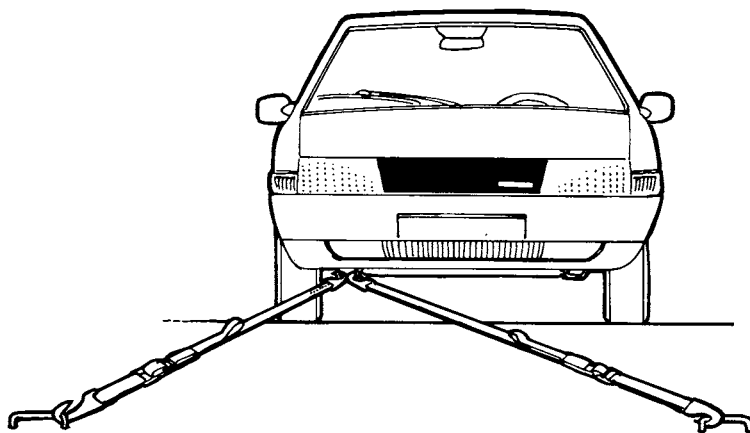

Seasafe Transport A/S

YOU NAME IT - WE LASH IT

Filipstadveien 5, N-0250 OSLO, Norway Phone: + 47 - 23 23 96 00 Telefax: + 47 - 23 23 96 01 E-mail: post@seasafe.no